

6VC3.4 6V3.4Ah

General Application

6VC3.4 is a general purpose battery with 3~5 years in standby service or more than 400 cycles at 50% depth of discharge in cycle service.

Specification

● NOMINAL VOLTAGE	: 6 V
● NOMINAL CAPACITY(20 hr)	: 3.4 Ah
● DIMENSIONS	
TOTAL HEIGHT	: 67 mm (2.64 inches)
CONTAINER HEIGHT	: 60 mm (2.36 inches)
LENGTH	: 134 mm (5.28 inches)
WIDTH	: 34 mm (1.34 inches)
● WEIGHT	: APPROX 0.69 Kg (1.52 lbs)
● CONTAINER MATERIAL	: UL94HB ABS
	: UL94V-0 ABS
● INTERNAL RESISTANCE(25°C , 77 °F)	: ~25.5 mΩ
● DISCHARGE CAPACITY UNDER DIFFERENT TEMPERATURES	
40°C	: ~102%
25°C	: ~100%
0 °C	: ~85%

Characteristics

● CAPACITY 25 °C / 77 °F	
20 hr @ 0.17 A	: 3.4 Ah
5 hr @ 0.54 A	: 2.7 Ah
1 hr @ 2.04 A	: 2.04 Ah
1 C @ 3.4 A	: 1.7 Ah
● CHARGING VOLTAGE (25°C , 77 °F)	
STANDBY USE	: 6.825V±0.075 V
CYCLE USE	: 7.35V±0.15 V
● MAX DISCHARGE CURRENT	: 40 A (5 sec)
● MAX CHARGING CURRENT	: 1.02 A
● SELF-DISCHARGE RESIDUAL CAPACITY(25°C , 77 °F)	
AFTER 3 MONTHS	: ~90%
AFTER 6 MONTHS	: ~82%
AFTER 12 MONTHS	: ~70%

Discharge Current vs Time

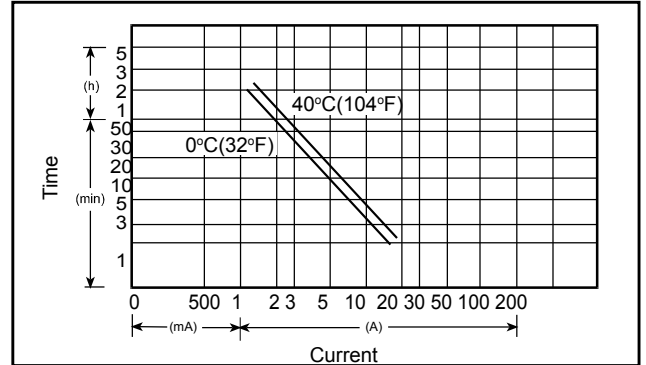

Discharge Characteristics @25 °C (77 °F)

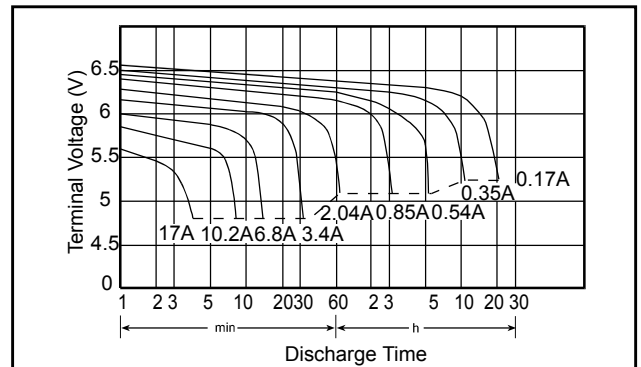

Dimensions

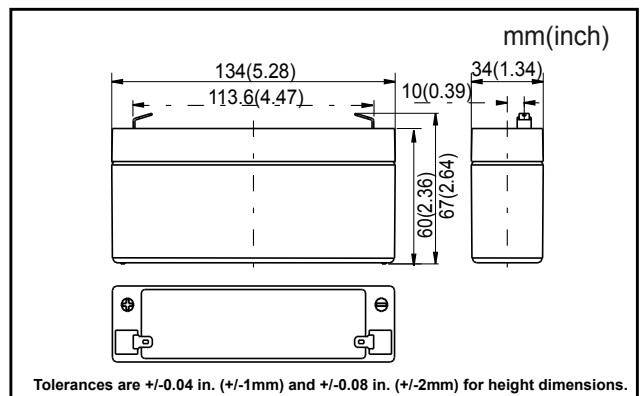

Terminal

